

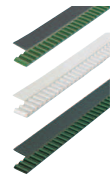

一下部金属件短型- 366	同步齿形带 -MXL·XL·L·H型- 367	高扭矩同步齿形带 -S2M·S3M·S5M·S8M·S14M型- 369	同步齿形带 -T5·T10型- 371
			
-聚氨酯·标准型·贴布型- 372	带附件同步齿形带 373	同步齿形带 375	-聚氨酯·氯丁橡胶- 376
			
同步齿形带用金属件 -过压防止型- 377	一下方过压防止金属件 螺帽固定型- 378		

Order 订购示例 **型式 ①Type** - **②皮带种类** · **③皮带公称宽度**
RD-SEKCR - **XL025**

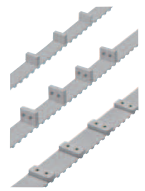

①Type	型式		W	A	B	T	h	L	P	d	安装孔数
	②皮带种类	③皮带公称宽度									
RD-SEKCR	XL	025	6.4	36	24	6	1.25	25	12	4.5	4
		031	7.9		25				14		
		037	9.5		26				16		
		050	12.7		30				20		
	L	050	12.7	66	32	8	1.9	50	20	5.5	4
		075	19.1		38				26		
		100	25.4		46				33		
		150	38.1		58				46		
	H	075	19.1	89	38	10	2.3	70	26	5.5	6
		100	25.4		46				33		
		150	38.1		58				45		
	S3M	060	6	21	20	4	1.14	15	11	3.4	4
		100	10		25				15		
		150	15		30				20		
	S5M	100	10	35	26	6	1.81	25	16	4.5	4
		150	15		32				21		
		250	25		42				31		
	S8M	150	15	56	34	8	2.85	40	22	5.5	4
250		25	44		32						
300		30	50		37						
400		40	60		47						
T5	100	10	35	26	6	1.2	25	16	4.5	4	
	150	15		32				21			
	200	20		38				26			
	250	25		43				31			
T10	150	15	70	34	8	2.5	50	22	5.5	6	
	200	20		40				27			
	250	25		44				32			
	300	30		50				37			

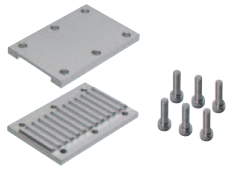
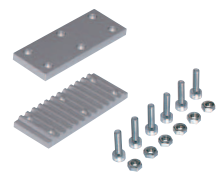
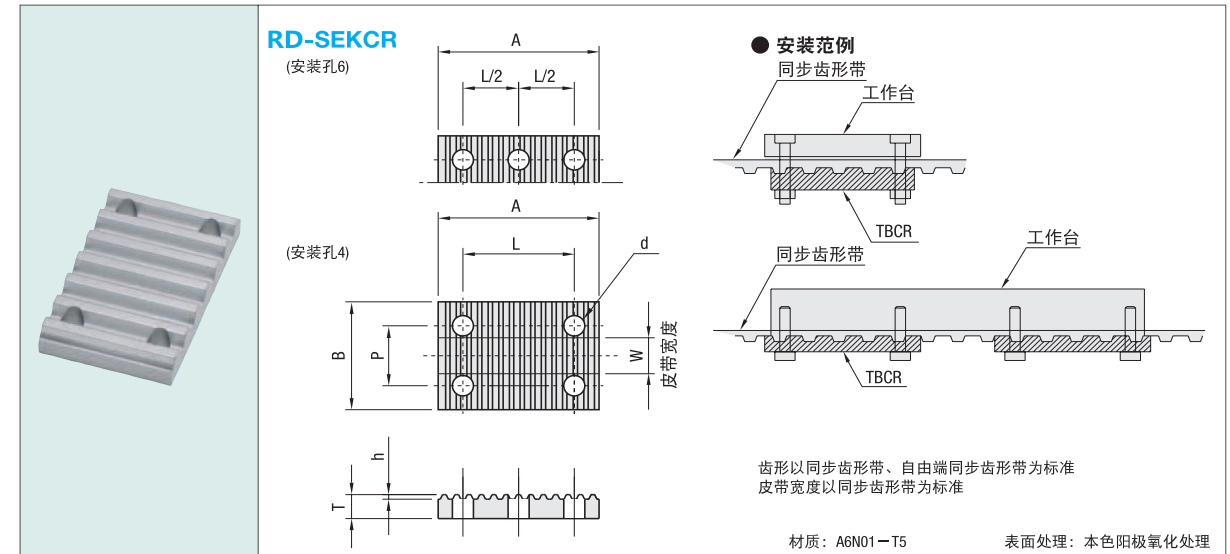
*S0M型的附件亦可用于P0M型皮带。



交货期



报价确定